

Owner's Manual & Safety Instructions

Save This Manual Keep this manual for the safety warnings and precautions, assembly, operating, inspection, maintenance and cleaning procedures. Write the product's serial number in the back of the manual near the assembly diagram (or month and year of purchase if product has no number). Keep this manual and the receipt in a safe and dry place for future reference.

REV 15g

PORTLAND™

ELECTRIC POLE SAW



Visit our website at: <http://www.harborfreight.com>
Email our technical support at: productsupport@harborfreight.com

ITEM 62896

When unpacking, make sure that the product is intact and undamaged. If any parts are missing or broken, please call 1-888-866-5797 as soon as possible.

Copyright© 2015 by Harbor Freight Tools®. All rights reserved.
No portion of this manual or any artwork contained herein may be reproduced in any shape or form without the express written consent of Harbor Freight Tools. Diagrams within this manual may not be drawn proportionally. Due to continuing improvements, actual product may differ slightly from the product described herein.
Tools required for assembly and service may not be included.

⚠ WARNING

**Read this material before using this product.
Failure to do so can result in serious injury.
SAVE THIS MANUAL.**

Table of Contents

Safety	2	Maintenance	11
Specifications	5	Parts List and Diagram	14
Assembly	5	Warranty	16
Operation	8		





SAFETY

ASSEMBLY

OPERATION

MAINTENANCE

WARNING SYMBOLS AND DEFINITIONS

	This is the safety alert symbol. It is used to alert you to potential personal injury hazards. Obey all safety messages that follow this symbol to avoid possible injury or death.
	Indicates a hazardous situation which, if not avoided, will result in death or serious injury.
	Indicates a hazardous situation which, if not avoided, could result in death or serious injury.
	Indicates a hazardous situation which, if not avoided, could result in minor or moderate injury.
	Addresses practices not related to personal injury.

IMPORTANT SAFETY INSTRUCTIONS

WARNING

When using electric gardening appliances, basic safety precautions should always be followed to reduce the risk of fire, electric shock, and personal injury, including the following:

READ ALL INSTRUCTIONS

Power Cord Safety



WARNING! - To reduce the risk of electric shock, use only with an extension cord intended for outdoor use, such as an extension cord of cord type

SW-A, SOW-A, STW-A, STOW-A, SJW-A, SJOW-A, SJTW-A. or SJTOW-A.

- Extension Cord** - Make sure your extension cord is in good condition. When using an extension cord, be sure to use one heavy enough to carry the current your product will draw. An undersized extension cord will cause a drop in line voltage resulting in loss of power and overheating.
- Ground Fault Circuit Interrupter (GFCI) protection should be provided on the circuit(s) or outlet(s) to be used for the gardening appliance.** Receptacles are available having built-in GFCI protection and may be used for this measure of safety.
- Do not Abuse Cord** - Do not carry appliance by cord or yank it to disconnect from receptacle. Keep cord from heat, oil, and sharp edges.
- To reduce the risk of electric shock, this appliance has a polarized plug (one blade is wider than the other) and will require the use of a polarized extension cord.** The appliance plug will fit into a polarized extension cord only one way. If the plug does not fit fully into the extension cord, reverse the plug. If the plug still does not fit, obtain a correct polarized extension cord.
- A polarized extension cord will require the use of a polarized wall outlet.** This plug will fit into the polarized wall outlet only one way. If the plug does not fit fully into the wall outlet, reverse the plug. If the plug still does not fit, contact a qualified electrician to install the proper wall outlet. Do not change the equipment plug, extension cord receptacle, or extension cord plug in any way. This design is referred to as double-insulated, indicated by .

6. **WARNING:** The cord of this product contains lead and/or di (2-ethylhexyl) phthalate (DEHP), chemicals known to the State of California to cause cancer, and birth defects or other reproductive harm. Wash hands after handling. (California Health & Safety Code § 25249.5, *et seq.*)

Extension Cord Size

The following table shows the correct cord size to use depending on cord length and nameplate ampere rating. If in doubt, use the next heavier gauge. The smaller the gauge number, the heavier the cord.

TABLE A – MINIMUM WIRE GAUGE FOR EXTENSION CORDS (120 VOLT)				
Ampere Rating (at full load)	EXTENSION CORD LENGTH			
	25'	50'	100'	150'
0 – 6	18	16	16	14
6 – 10	18	16	14	12
10 – 12	16	16	14	12
12 – 16	14	12	Not recommended	

Connecting Cords

To reduce the risk of the cords pulling apart during operation, do one of the following:

- a. Make a knot as shown below then connect the cords:

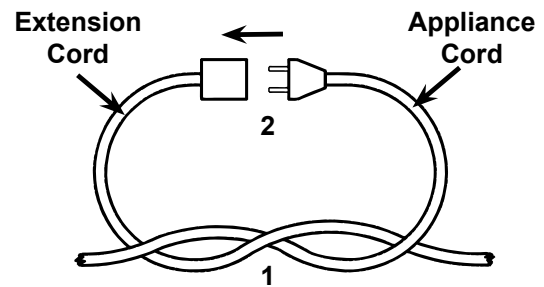

- b. Or, use a plug-receptacle retaining strap or connector designed to hold extension cords to appliance cords.

7. **WARNING:** This product contains di (2-ethylhexyl) phthalate (DEHP), a chemical known to the State of California to cause cancer and birth defects or other reproductive harm. (California Health & Safety Code § 25249.5, *et seq.*)

Personal Safety

- Dress Properly** - Do not wear loose clothing or jewelry. They can be caught in moving parts. Use of rubber gloves and substantial footwear is recommended when working outdoors. Wear protective hair covering to contain long hair.
-  **Wear ANSI-approved safety goggles, hard hat and heavy-duty rubber work gloves.** Use face or dust mask if operation is dusty.
- Avoid Unintentional Starting** - Do not carry plugged-in appliance with finger on switch. Be sure switch is off when plugging in.
- Do not Overreach** - Keep proper footing and balance at all times.
- Stay Alert** - Watch what you are doing. Use common sense. Do not operate appliance when you are tired.
- DANGER! People with pacemakers should not use pole saws.** Pole saws produce strong electromagnetic fields that can cause pacemaker interference or pacemaker failure. People with pacemakers should consult their physician(s) for advice.

Gardening Appliance Use and Care

- Avoid Dangerous Environment** - Do not use appliances in damp or wet locations.
- Do Not Use In Rain.**
- Keep Children Away** - All visitors should be kept at a distance from work area.
- When servicing use only identical replacement parts.**
- Use Right Appliance** - Do not use appliance for any job except that for which it is intended.
- Do Not Force Appliance** - It will do the job better and with less likelihood of injury at the rate for which it was designed.
- Store Idle Appliances Indoors** - When not in use, appliances should be stored indoors in dry, and high or locked-up place - out of reach of children.
- Disconnect Appliance** - Disconnect the appliance from the power supply when not in use, before servicing, when changing accessories such as blades, and the like.

9. **Check Damaged Parts** - Before further use of the appliance, a guard or other part that is damaged should be carefully checked to determine that it will operate properly and perform its intended function. Check for alignment of moving parts, binding of moving parts, breakage of parts, mounting, and any other condition that may affect its operation. A guard or other part that is damaged should be properly repaired or replaced by a qualified technician unless indicated elsewhere in this manual.
10. **Carefully follow cutting procedures explained in this manual.** They are specifically planned to reduce risk to the operator.
11. **Lock pole in place securely before using Pole Saw.**
12. **Maintain Appliance With Care** - Keep cutting edge sharp and clean for best performance and to reduce the risk of injury. Follow instructions for lubricating and changing accessories. Inspect appliance cord periodically, and if damaged, have it repaired by an authorized service facility. Inspect extension cords periodically and replace if damaged. Keep handles dry, clean, and free from oil and grease.

Vibration Hazard

This appliance vibrates during use. Repeated or long-term exposure to vibration may cause temporary or permanent physical injury, particularly to the hands, arms and shoulders. To reduce the risk of vibration-related injury:

1. **Anyone using vibrating appliances regularly or for an extended period should first be examined by a doctor and then have regular medical check-ups to ensure medical problems are not being caused or worsened from use.** Pregnant women or people who have impaired blood circulation to the hand, past hand injuries, nervous system disorders, diabetes, or Raynaud's Disease should not use this appliance. If you feel any symptoms related to vibration (such as tingling, numbness, and white or blue fingers), seek medical advice as soon as possible.
2. **Do not smoke during use.** Nicotine reduces the blood supply to the hands and fingers, increasing the risk of vibration-related injury.
3. **Wear suitable gloves to reduce the vibration effects on the user.**
4. **Use appliances with the lowest vibration when there is a choice between different processes.**
5. **Include vibration-free periods each day of work.**
6. **Grip appliance as lightly as possible (while still keeping safe control of it).** Let the appliance do the work.
7. **To reduce vibration, maintain the appliance as explained in this manual.** If any abnormal vibration occurs, stop use immediately.

General Safety

1. **Stop working when you feel tired or exhausted.** Make regular breaks to rest.
2. **Keep all parts of the body away from saw chain.** Do not remove cut material or hold material to be cut when saw chain is moving. Make sure the switch is off when clearing jammed material.
3. **Hold Pole Saw by insulated gripping surfaces only,** because the saw chain may contact hidden wiring or its own cord. Saw chains contacting a "live" wire may make exposed metal parts of the garden power tool "live" and could give the operator an electric shock.
4. **Keep power cord away from cutting area.** During operation the power cord may be hidden in shrubs and can be accidentally cut by the blade.
5. **Before use, make sure the saw chain is not contacting anything.**
6. **Hold Pole Saw with both hands on the handle.**
7. **Do not operate Pole Saw from within a tree.** Operation of tool while up in a tree may result in personal injury.
8. **Keep proper footing and operate the garden power tool only when standing on fixed, secure and level surface.** Slippery or unstable surfaces such as ladders may cause a loss of balance or control of the garden power tool.
9. **When cutting a limb that is under tension, be alert for spring back.** When the tension in the wood fibers is released, the limb may strike the operator and/or throw the tool out of control.
10. **Use extreme caution when cutting brush and saplings.** The slender material may catch the saw chain and be whipped around.
11. **Carry Pole Saw with tool switched off and away from your body.** Proper handling of the Pole Saw will reduce the likelihood of accidental contact with the moving saw chain.

12. **Follow instructions for lubricating, chain tensioning and changing accessories.** Improperly tensioned or lubricated chain may either break or increase the chance for kickback.
13. **Kickback is the result of tool misuse and/or incorrect operating procedures or conditions.** Kickback may occur when the nose or tip of the guide bar touches an object, or when the wood closes in and pinches the saw chain in the cut.
- Kickback can be avoided by taking proper precautions as given below:
- Maintain a firm grip, with thumbs and fingers encircling the Pole Saw handles, with both hands on the saw and position your body and arm to allow you to resist kickback forces. Kickback forces can be controlled by the operator, if proper precautions are taken. Do not let go of the garden power tool.
 - Do not overreach. This helps prevent unintended tip contact and enables better control of the garden power tool in unexpected situations.
 - Only use replacement bars and chains specified by the manufacturer. Incorrect replacement bars and chains may cause chain breakage and/or kickback.
- d. Follow the manufacturer's sharpening and maintenance instructions for the saw chain. Decreasing the depth gauge height can lead to increased kickback.
- Keep handles dry, clean, and free from oil and grease.**
 - Use for cutting wood only.** Do not use for cutting plastic, masonry or non-wood building materials.
 - Do not touch guide bar tip to any object.** Tip contact may cause guide bar to move suddenly upward and backwards.
 - Maintain labels and nameplates on the appliance.** These carry important safety information. If unreadable or missing, contact Harbor Freight Tools for a replacement.
 - The warnings, precautions, and instructions discussed in this instruction manual cannot cover all possible conditions and situations that may occur.** It must be understood by the operator that common sense and caution are factors which cannot be built into this product, but must be supplied by the operator.



SAVE THESE INSTRUCTIONS.

Specifications

Electrical Rating	120VAC / 60Hz / 6.5A
Reach	6' to 8'10"
Bar Length	9.5"



Assembly Instructions



Read the **ENTIRE IMPORTANT SAFETY INSTRUCTIONS** section at the beginning of this manual including all text under subheadings therein before set up or use of this product.

WARNING

TO PREVENT SERIOUS INJURY FROM ACCIDENTAL OPERATION:
Release the Trigger and unplug the appliance from its electrical outlet before assembling or making any adjustments.

Note: For additional information regarding the parts listed in the following pages, refer to the Assembly Diagram near the end of this manual.

Saw Chain Assembly

SAFETY

1. Set the Pole Saw on a suitable flat surface with the cover facing upwards.
2. Use Hex Wrench (65) to remove the Sprocket Clamp (60-3) and End Cap (60-2). See Figure 1, right.

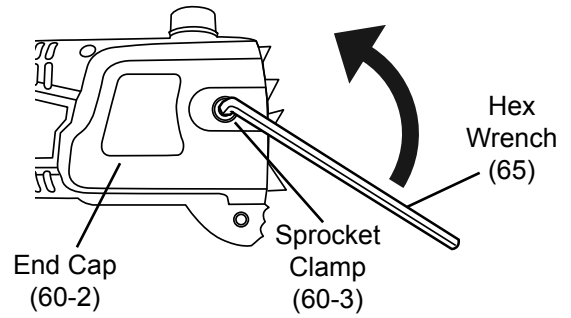

Figure 1

ASSEMBLY

3. Spread the Saw Chain (63) out with the cutting edges of the chain pointing in the direction of rotation.
4. Slide the chain into the slot around the Chain Cover (64). See Figure 2, right.

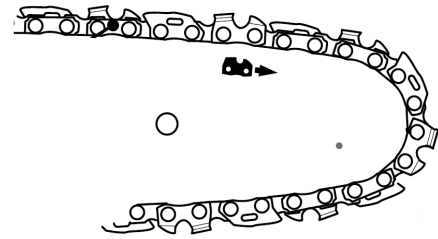

Figure 2

Note: Verify chain is installed with correct direction of rotation.

5. Use the Hex Wrench to turn the chain tension screw counterclockwise. The Tension Pin (51) is moved toward the left. See Figure 3, right.

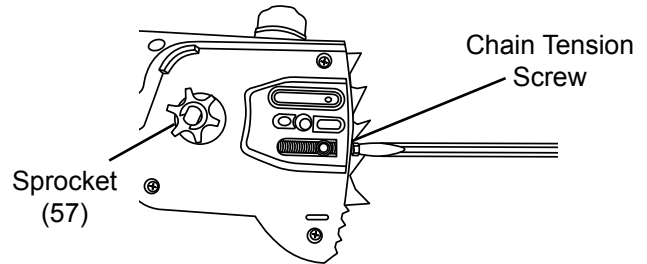

Figure 3

OPERATION

6. Mount Saw Chain assembly over the Sprocket (57) and align the slot in the Chain Cover with the Guide Rail (62). Push the Chain Cover to the left towards the Sprocket.

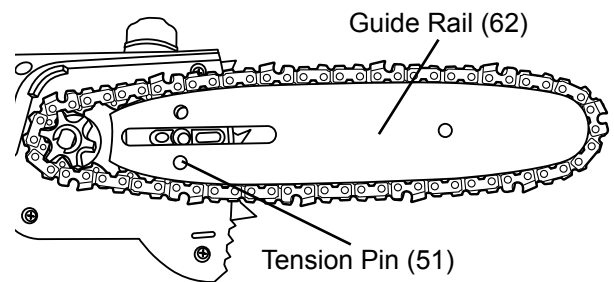

Figure 4

Note: Make sure the tension pin is inserted into the lower hole on the Guide Rail. See Figure 4, right.

MAINTENANCE

7. Replace the Sprocket Clamp and End Cap and fasten back in place using Hex Wrench. See Figure 5, right.

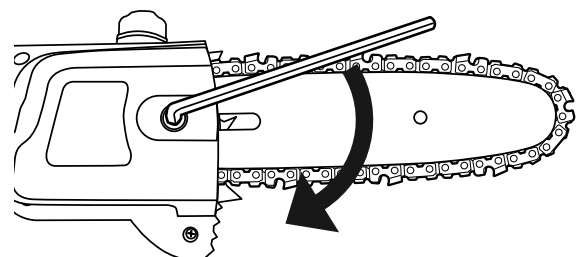

Figure 5

Tensioning Saw Chain

Check the saw chain tension before use, after the first initial cuts, and periodically after regular use (about every 5 cuts).

WARNING! A loose chain will increase the risk of kickback and may jump out of guide bar groove, leading to possible injury and property damage. A loose chain can also lead to rapid wear to chain and sprocket.

Note: After initial use, new chains can lengthen considerably. This is normal during the break-in period. Future adjustments will lengthen Saw Chain more gradually.

WARNING! Unplug Pole Saw from power outlet before adjusting saw chain tension.

1. Set Pole Saw on a suitable flat surface.

WARNING! Sharp cutting edges on saw chain. Wear heavy-duty work gloves whenever handling Saw Chain.

2. Use the flat end of the Hex Wrench to turn the chain tension screw clockwise until the chain tie straps just touch the bottom edge of the guide bar. See Figure 6, left.
3. The correct chain tension is reached when the Saw Chain can be lifted by 2-4 mm from the center of the chain bar. Use one hand to lift the chain against the weight of the machine. See Figure 7, left.

WARNING! Tensioning saw chain too tightly will overload the motor and cause damage. Insufficient tension can cause chain to derail.

Note: The chain life depends mainly upon sufficient lubrication and correct tensioning.

Lubricating Pole Saw

Note: The Pole Saw is not filled with oil. Fill with oil before using. The Pole Saw is equipped with an automatic oiling system. The oiling system automatically delivers the proper amount of oil to the bar and chain.

1. Set Pole Saw down with the Oil Tank Cap (13) facing upward.
2. Add lubrication oil (either SAE30 or SAE10) until reservoir is full.
3. The oil tank holds 110ml lubrication oil, which will lubricate the chain for 20-25 minutes of cutting. The oil tank level can be checked by way of the oil level gauge. See Figure 8, left.
4. Check oil level gauge before start-up and regularly during operation. Refill oil before oil level is lower than "MIN" marking.
5. Use clean cloth to wipe up an excess or spilled oil.
6. Replace oil filler cap and tighten.
7. **WARNING!** Do not operate Pole Saw without enough lubrication oil. Running the Pole Saw dry or with too little oil will decrease cutting efficiency, shorten Saw Chain life, and cause rapid wear and overheating.

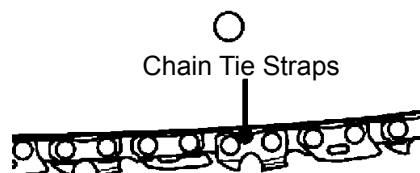

Figure 6

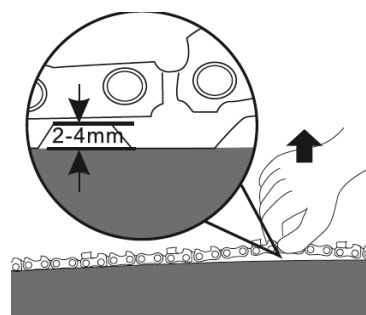

Figure 7

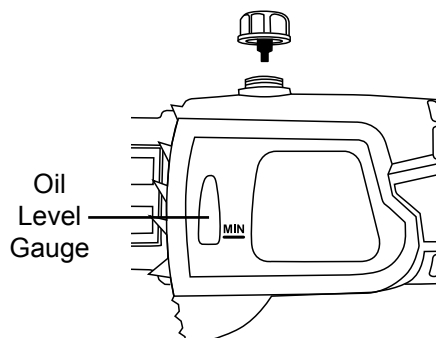

Figure 8

Operating Instructions



Read the **ENTIRE IMPORTANT SAFETY INFORMATION** section at the beginning of this manual including all text under subheadings therein before set up or use of this product.

- Before operating the gardening appliance, put on ANSI-approved safety goggles, hard hat and other safety gear. Safety goggles and other safety gear are sold separately.
- If an extension cord is used, ensure that it is an outdoor type extension cord and that it is the correct design to accept this appliance's plug.



WARNING! TO PREVENT ELECTRIC SHOCK AND SERIOUS PERSONAL INJURY:

The extension cord must remain secured to the appliance's plug. Secure the extension cord by either using the knot method explained in the safety warning section, or by using a device designed specifically for retaining the extension cord (sold separately).

Power Cord Routing

1. Route the power cord away from the work area to prevent it from contacting with the blade. Plan your route before starting work. Start your work at the nearest point to the electrical outlet, and work away from it. This will keep the power cord away from the Pole Saw and avoid it being accidentally cut.
2. Keep the power cord over your shoulder for added safety.
3. For tension relief of the power cord, loop the cord and bring this through the opening at the handle and insert it into the Cable Hook. See Figure 10, right.

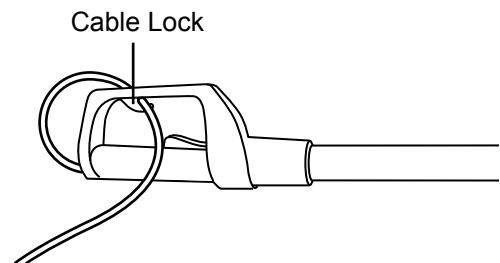

Figure 10

Adjusting Cutting Length

WARNING! Always release the Trigger and unplug the Pole Saw before any adjustment.

1. The cutting length of the Pole Saw can be adjusted according to required cutting height. Unscrew the locking sleeve in clockwise direction and adjust the pole bar.
2. After adjusting required length, tighten the locking sleeve. See Figure 11, right.

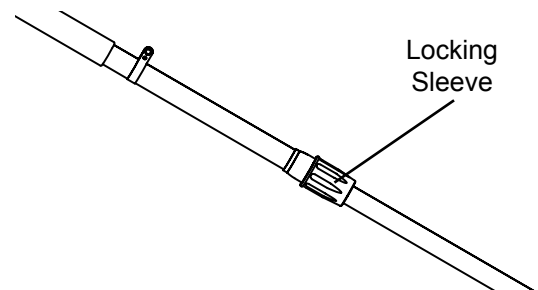

Figure 11

Activating/Deactivating Pole Saw

1. The Pole Saw is fitted with a lock button feature. To start Pole Saw, depress the Lock Button then fully press and hold the Trigger. The Lock Button can now be released. See Figure 12, right.

Note: It is not necessary to maintain pressure on the Lock Button once the Trigger is squeezed and the motor is running. The Lock Button is a safety device to avoid accidental start-up of the device.

2. The Pole Saw will automatically stop once the Trigger is released. The Lock Button will have to be depressed and the switch trigger squeezed to restart the Pole Saw motor.

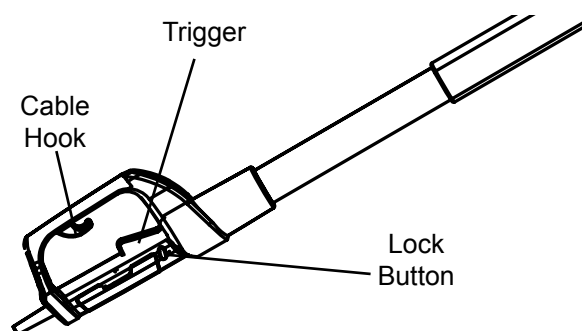

Figure 12

Avoiding Kickback During Use

1. Kickback occurs when the chain (at the tip of the guide bar) comes in contact with a log or wood, or when the saw chain becomes jammed, often when sawing sideward, slanted or during lengthwise cuts.

WARNING! When kickback occurs, the Pole Saw can react unpredictably and cause severe injuries to the operator or bystanders.

2. To avoid kickback:
 - a. Saw with guide bar at a flat angle
 - b. Do not work with a loose, overstretched or worn out chain
 - c. Ensure chain is sharpened correctly
 - d. Do not work with the tip of the guide bar
 - e. Hold the chain saw firmly with both hands
 - f. Use a low kickback chain
 - g. Ensure correct chain tension.

Handling Pole Saw

1. Hold the Pole Saw with both hands using the soft grip.
2. Fully grip both handles at all times during operation.

WARNING! Do not operate Pole Saw using only one hand.

3. Hold the Pole Saw at a max. angle of 60° from the horizontal level. See Figure 13, right.

WARNING! Do not stand directly under the limb you are sawing. Objects may fall different than expected. Position yourself well out of the path of falling limbs. Keep bystanders away from cutting end of garden power tool and a safe distance from the work area.

4. Maintain a minimum distance of thirty feet to bystanders.

WARNING! Do not stand on a ladder or other support while using Pole Saw.

5. Make sure the power cord is located to the rear, away from the chain and wood, and kept free of branches during cutting.

6. Hold the Pole Saw to the side of your body.

WARNING! Do not operate the Pole Saw with arms fully extended or attempt to saw areas that are difficult to reach.

7. Keep a firm, steady pressure on the Pole Saw while working. Do not try to force the Pole Saw through the wood, let the chain do the work. Use the gripping teeth to apply minimal leverage pressure.
8. Use caution when reaching end of cut. The Pole Saw's weight may change unexpectedly as it cuts free from the wood. Always remove the Pole Saw from a wood cut while it is running.

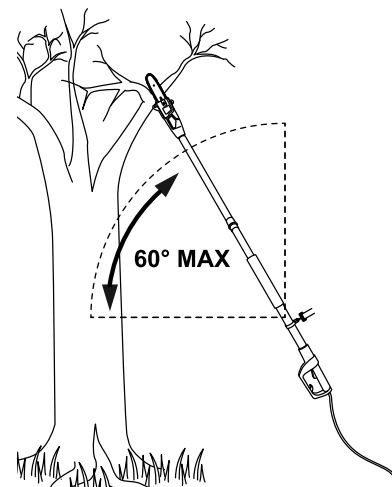

Figure 13

PORTLAND™

Cutting Thin Branches

1. Thin branches can be cut off with a single cut.
2. To prevent the branch from splintering and buckling, cut the branch off in several pieces. See Figure 14, right.

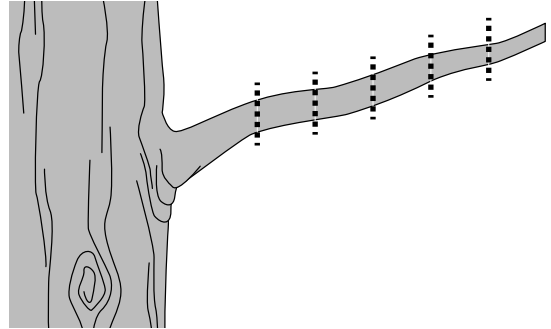

Figure 14

Cutting Thick Branches

1. When cutting larger branches, the following four cuts are necessary:
 - a. First cut into the branch from below, outside of the location where you intend to cut off the branch. The cut should go one third to halfway through the branch. See Cut 1 on Figure 15, right.
 - b. Cut into the branch from the top, making sure it's outside from where the branch is to be sawn. See Cut 2 on Figure 15, right.
 - c. To keep stump and branch from splintering, do a stub undercut below branch. See Cut 3, on Figure 15, right.
 - d. Cut off the stump with one clean cut from top to bottom. If desired, seal the cut with a suitable compound. See Cut 4 on Figure 15, right.
2. When finished cutting, turn off the Pole Saw and disconnect its power supply after use.
3. Clean, then store the appliance indoors out of children's reach.

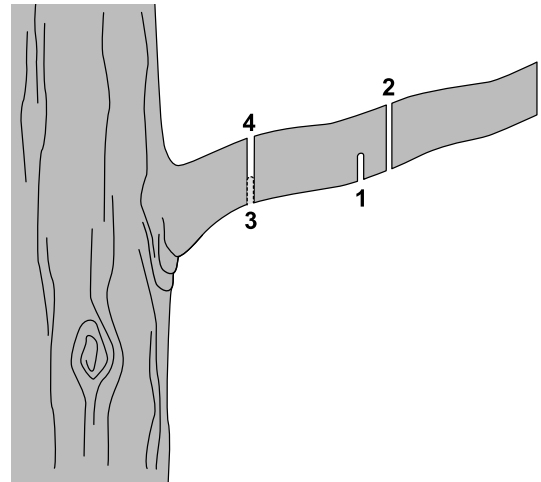

Figure 15

Maintenance And Servicing



Procedures not specifically explained in this manual must be performed only by a qualified technician.

!WARNING

TO PREVENT SERIOUS INJURY FROM ACCIDENTAL OPERATION OR ELECTRIC SHOCK: Release the Trigger and unplug the appliance from its electrical outlet before performing any inspection, maintenance, or cleaning procedures.

TO PREVENT SERIOUS INJURY FROM TOOL FAILURE: Do not use damaged equipment. If abnormal noise or vibration occurs, have the problem corrected before further use.

Cleaning, Maintenance and Lubrication

1. **BEFORE EACH USE**, inspect the general condition of the appliance. Check for loose screws, misalignment or binding of moving parts, cracked or broken parts, damaged electrical wiring, and any other condition that may affect its safe operation.
2. **AFTER USE**, clean external surfaces of the appliance with clean, moist cloth.
3. **REGULARLY** check for loose, dislodged or damaged chain and guide bar, loose fixings and worn or damaged components.
4. Check that covers and guards are undamaged and correctly fitted. **WARNING! Do not use Pole Saw if guards are damaged.** Make sure that all repairs are handled by a qualified service technician.
5. Clean Pole Saw with a brush or cloth. **WARNING! Do not clean the Pole Saw while it is running.**
6. Do not use any solvents or water to remove dirt.
7. Ensure that all hardware (screws, nuts, etc.) is tight at all times so that you can safely work with the Pole Saw.
8. **!WARNING! If the supply cord of this appliance is damaged, it must be replaced only by a qualified service technician.**
9. Store Pole Saw in a dry, secure location away from children.

Replacing/Changing Saw Chain and Guide Bar

1. Check the condition of the saw chain and its mounting at regular intervals.
 - a. If the saw chain is worn or blunt it must be replaced or sharpened immediately;
 - b. If the Pole Saw starts to suffer from excessive vibrations, this means that the saw chain or guide bar has not been balanced correctly or has suffered deformation due to impacts. In this case it must be repaired or replaced.
 - c. Assemble the chain and guide bar as described in "Saw Chain Assembly and Tensioning" sections on pages 6 and 7.
2. Over time, the circular groove of the guide bar will show wear on the lower edge. When replacing the chain, turn the chain bar 180° to allow even wear, extending chain bar life.
3. If the guide bar is worn out or damaged, replace it with an identical guide bar.

Lubricating Drive Sprocket

1. Unplug the chain saw from the power source.

Note: It is not necessary to remove the saw chain to lubricate the guide bar sprocket tip.

2. After about every ten uses, clean the guide bar sprocket tip.
3. Using disposable lube gun (not included), insert needle nose into the lubrication hole and inject grease until it appears at the outside edge of the sprocket tip. See Figure 16, right.
4. Make sure to switch Pole Saw off and rotate the saw chain by hand. Repeat the lubrication procedure until the entire sprocket tip has been greased.
5. Check drive sprocket. If it is worn out or damaged, have it replaced by a qualified service technician.

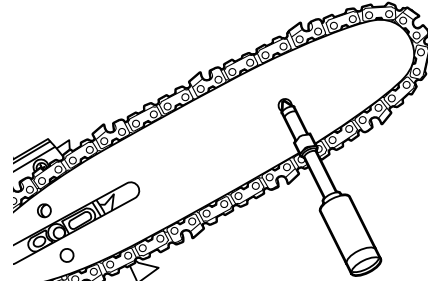

Figure 16

Cleaning Guide Bar Rails

1. Remove side cover, guide bar and saw chain.
2. After every ten regular uses, take a screwdriver or putty knife (not included) and clear residue from the rails on the guide bar. This will keep the oil passages open to provide proper lubrication to the bar and chain. See Figure 17, right.
3. Reinstall the bar, chain (adjust tension), sprocket cover and bar bolt retaining nuts.

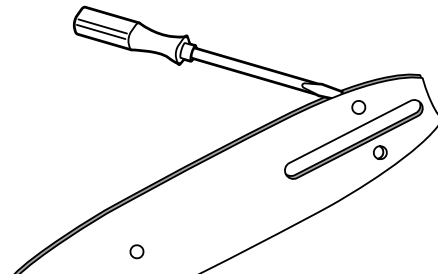

Figure 17

Sharpening Saw Chain

1. Ensure the chain is correctly tensioned. See Figure 18, right.

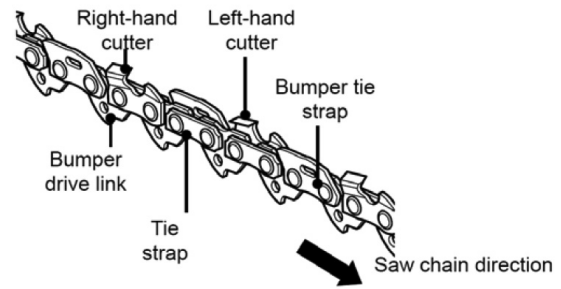

Figure 18

2. Use a round file (not included) with a diameter of 1.1 times the cutting tooth depth. Make sure 20 percent of the file diameter is above the cutter's top plate.
3. File at an angle perpendicular to the bar and at an angle of 25 degrees to the direction of travel. See Figure 19, right.

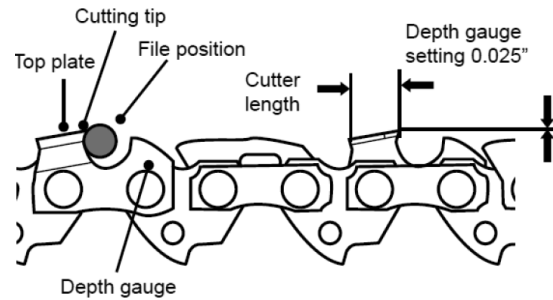

Figure 19

4. File each tooth from the inside towards outside only. File one side of the chain first, then turn the Pole Saw around and repeat the process.
5. Sharpen each tooth equally by using the same number of strokes. See Figure 20, right.
6. Keep all cutter lengths equal.
7. If the depth gauges are also trimmed, make sure the original profile be restored. Use a depth gauge measuring instrument to check the height of the depth gauge.

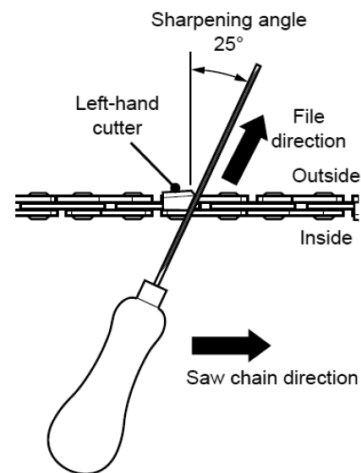

Figure 20

Troubleshooting

Problem	Possible Causes	Likely Solutions
Pole Saw does not start.	<ol style="list-style-type: none"> 1. Power supply interrupted. 2. Power cord or plug is damaged. 3. Other electrical defect to Pole Saw. 	<ol style="list-style-type: none"> 1. Check the power supply. 2. Have a certified electrician check power cord and plug. 3. Have a certified electrician check Pole Saw.
Pole Saw does not operate at full output.	<ol style="list-style-type: none"> 1. Extension cord is too long and/or has cross section is too small. 2. Power supply voltage (generator) is too low. 	<ol style="list-style-type: none"> 1. Check and adjust rip fence. 2. Connect Pole Saw to another power outlet.
Bade cutting result.	<ol style="list-style-type: none"> 1. Saw chain not tensioned properly. 2. Saw chain dull. 	<ol style="list-style-type: none"> 1. Tension saw chain properly 2. Sharpen saw chain or replace.



Follow all safety precautions whenever diagnosing or servicing the tool. Disconnect power supply before service.

Parts List and Diagram

PLEASE READ THE FOLLOWING CAREFULLY

THE MANUFACTURER AND/OR DISTRIBUTOR HAS PROVIDED THE PARTS LIST AND ASSEMBLY DIAGRAM IN THIS MANUAL AS A REFERENCE TOOL ONLY. NEITHER THE MANUFACTURER OR DISTRIBUTOR MAKES ANY REPRESENTATION OR WARRANTY OF ANY KIND TO THE BUYER THAT HE OR SHE IS QUALIFIED TO MAKE ANY REPAIRS TO THE PRODUCT, OR THAT HE OR SHE IS QUALIFIED TO REPLACE ANY PARTS OF THE PRODUCT. IN FACT, THE MANUFACTURER AND/OR DISTRIBUTOR EXPRESSLY STATES THAT ALL REPAIRS AND PARTS REPLACEMENTS SHOULD BE UNDERTAKEN BY CERTIFIED AND LICENSED TECHNICIANS, AND NOT BY THE BUYER. THE BUYER ASSUMES ALL RISK AND LIABILITY ARISING OUT OF HIS OR HER REPAIRS TO THE ORIGINAL PRODUCT OR REPLACEMENT PARTS THERETO, OR ARISING OUT OF HIS OR HER INSTALLATION OF REPLACEMENT PARTS THERETO.

Parts List

Part	Description	Qty	Part	Description	Qty	Part	Description	Qty
1	Power Cord	1	25	Label	1	42	Hex Nut (M5)	1
2	Strain Relief	1	26	Oil Connector	1	43	Bearing (606)	1
3	ST Screw 4*14	5	27	Oil Tube	1	44	Retaining Ring	1
4	ST Screw 4*12	1	28	Oil Tube Spring	1	45	Big Gear	1
5	Right Handle	1	29	Pump	1	46	Output Shaft	1
6	ST Screw 4*12	2	29-1	Turbine Gear	1	47	Bearing (6900)	1
7	Cable Clamp	1	29-2	Turbine	1	48	ST Screw 4*12	4
8	Control Switch	1	29-3	Piston Frame	1	49	Right Housing Inlay	1
9	Left Handle	1	29-4	Piston Sleeve	1	49-1	Machine Screw 4*8	1
10	Lock Switch Spring	1	29-5	Pump Body	1	49-2	Washer	1
11	Trigger	1	29-6	Pump Spring	1	49-3	Self Locking Nut (M8)	1
12	Lock Switch	1	30	Flange ST Screw 3*8	2	49-4	Rt. Hsg. Inlay Gasket	1
13	Spring	1	31	Tank	1	49-5	Right Housing Inlay	1
14	Cable Clamp	1	31-1	Oil Tube Spring	1	49-6	Oil Output Gasket	1
15	ST Screw 4*12	2	31-2	Oil Tube	1	50	Stretching Screw	1
16	ST Screw 5*20	2	31-3	Tank Gasket	1	51	Tension Pin	1
17	Spring Wire	1	31-4	Tank Connector	1	52	Sponge Washer	1
18	Tube	1	31-5	Sponge	1	53	Rubber Pad	2
18-1	Middle Tube	1	31-6	Choke Plug	1	54	Sponge Washer	3
18-2	Rivet	2	31-7	Tank	1	55	Right Housing	1
18-3	Draw Tube Reed	1	32	Tank Cap	1	56	ST Screw 4*14	8
18-4	Tube Connector	1	32-1	Valve	1	57	Sprocket	1
18-5	Tube Conn. Washer	1	32-2	Tank Cap Gasket	1	58	Retaining Ring	1
18-6	Tube Conn. Sleeve	1	32-3	Tank Cap	1	59	ST Screw 5*20	2
18-7	Tube Connector	1	32-4	Tank Cap Cover	1	60	End Cap	1
18-8	Guide Pin	1	33	Wire (L-70)	2	60-1	End Cap Gasket	1
18-9	Big Retaining Ring	1	34	Stator	1	60-2	End Cap	1
18-10	Tube Sleeve	1	35	Bearing (607)	1	60-3	Sprocket Clamp	1
18-11	Large Tube	1	36	Carbon Brush	2	60-4	Nameplate	1
20	Left Housing	1	37	Bushing	2	61	Inner Hex Screw 8*25	1
21	Cable Clamp	1	38	Brush Holder	2	62	Guide Bar	1
22	ST Screw 4*12	2	39	Rotor	1	63	Saw Chain	1
23	Sponge Washer	1	40	Bearing (608)	1	64	Chain Cover	1
24	Sponge Washer	1	41	Small Gear	1	65	Hex Wrench	1

Record Product's Serial Number Here: _____

Note: If product has no serial number, record month and year of purchase instead.

Note: Some parts are listed and shown for illustration purposes only, and are not available individually as replacement parts.

Assembly Diagram

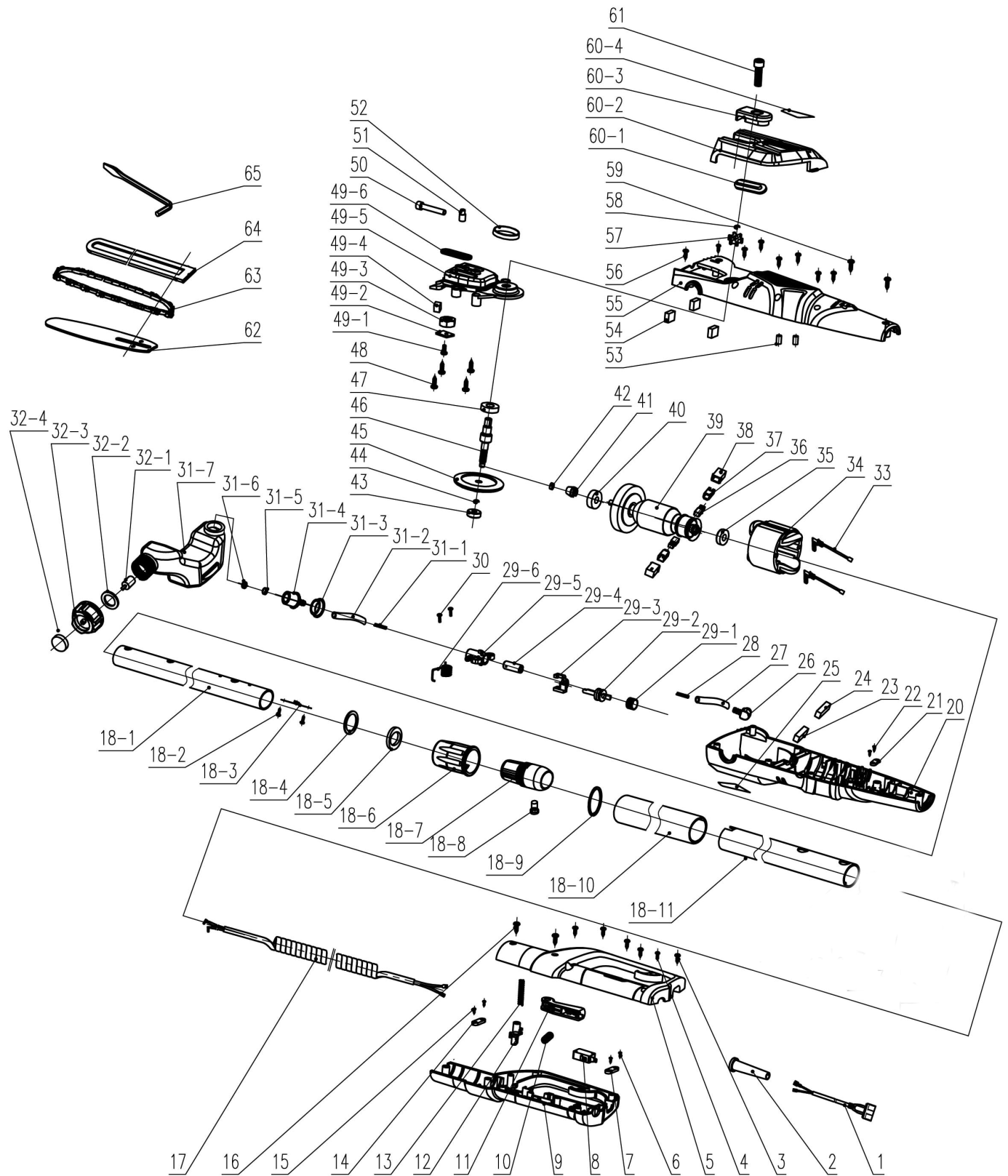

SAFETY

ASSEMBLY

OPERATION

MAINTENANCE

Limited 90 Day Warranty

Harbor Freight Tools Co. makes every effort to assure that its products meet high quality and durability standards, and warrants to the original purchaser that this product is free from defects in materials and workmanship for the period of 90 days from the date of purchase. This warranty does not apply to damage due directly or indirectly, to misuse, abuse, negligence or accidents, repairs or alterations outside our facilities, criminal activity, improper installation, normal wear and tear, or to lack of maintenance. We shall in no event be liable for death, injuries to persons or property, or for incidental, contingent, special or consequential damages arising from the use of our product. Some states do not allow the exclusion or limitation of incidental or consequential damages, so the above limitation of exclusion may not apply to you. THIS WARRANTY IS EXPRESSLY IN LIEU OF ALL OTHER WARRANTIES, EXPRESS OR IMPLIED, INCLUDING THE WARRANTIES OF MERCHANTABILITY AND FITNESS.

To take advantage of this warranty, the product or part must be returned to us with transportation charges prepaid. Proof of purchase date and an explanation of the complaint must accompany the merchandise. If our inspection verifies the defect, we will either repair or replace the product at our election or we may elect to refund the purchase price if we cannot readily and quickly provide you with a replacement. We will return repaired products at our expense, but if we determine there is no defect, or that the defect resulted from causes not within the scope of our warranty, then you must bear the cost of returning the product.

This warranty gives you specific legal rights and you may also have other rights which vary from state to state.

PORTLAND™