

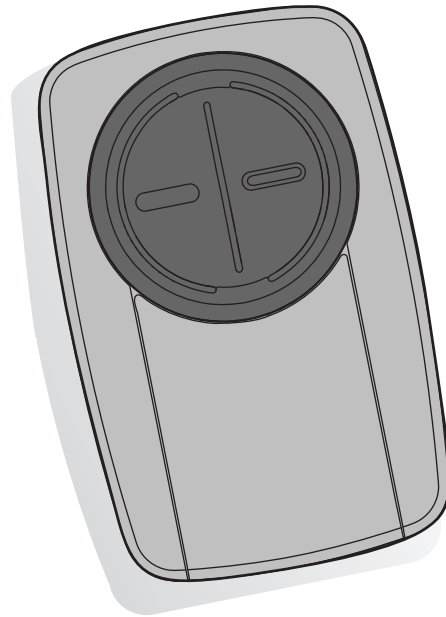

MODEL KLIK3U

Universal Remote Control



Read instructions thoroughly BEFORE beginning.

If using the Universal Remote Control with residential door openers, the remote control must be used only with door openers manufactured after 1993 that utilize photoelectric sensors. The photoelectric sensors are always located on or near the bottom of the door track.

WARNING

To prevent possible **SERIOUS INJURY** or **DEATH** from a moving gate or door:

- ALWAYS keep remote controls out of reach of children. NEVER permit children to operate, or play with remote control transmitters.
- Activate gate or door **ONLY** when it can be seen clearly, is properly adjusted and there are no obstructions to door travel.
- ALWAYS keep gate or door in sight until completely closed. NEVER permit anyone to cross path of moving gate or door.

GETTING STARTED

The remote control can be programmed to activate up to two products, such as a garage door opener, gate operator, or commercial door operator. The images throughout this manual are for reference only and your product may look different.

Garage Door Opener

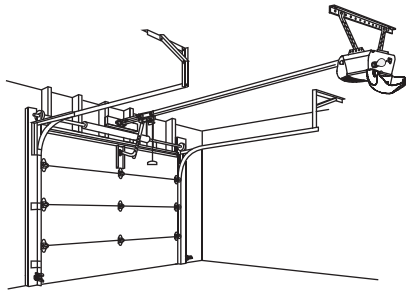

Gate Operator

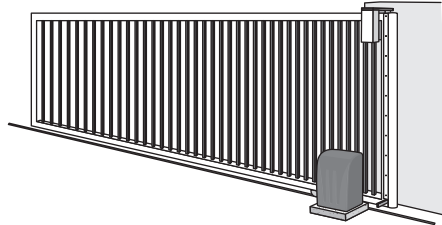

Commercial Door Operator

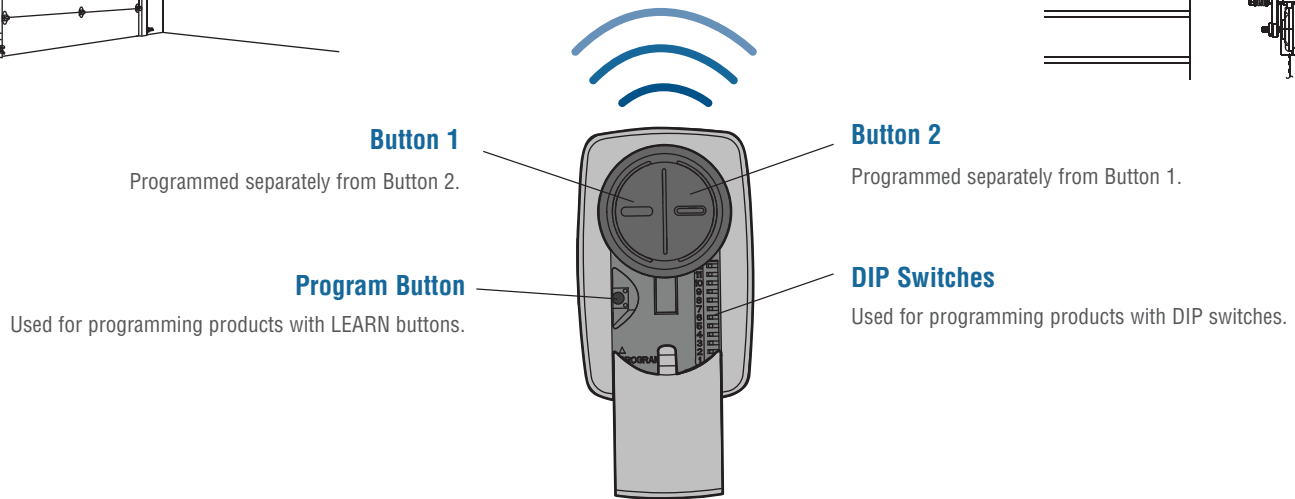
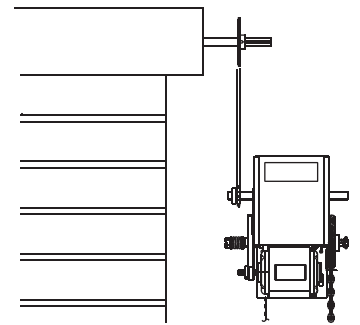

Depending on your product, there is a button (LEARN button) or DIP switches used for programming. You will need to locate the LEARN button or DIP switches on your product before you start programming.

GARAGE DOOR OPENERS

The LEARN button or DIP switches are typically located on the back or side panel of your garage door opener. Your LEARN button may have a different name (SMART button, PROGRAM button, SET button, etc.). For help locating your LEARN button or DIP switches refer to the Help section in this manual or contact your garage door opener manufacturer.

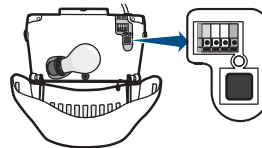

COMMERCIAL DOOR OPERATORS

The LEARN button or DIP switches are typically located on the logic board of your operator. Your LEARN button may have a different name (RADIO button, XMITTER button, etc.). For help locating your LEARN button or DIP switches contact your door operator manufacturer.

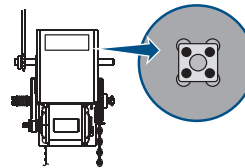

GATE OPERATORS

The LEARN button or DIP switches are typically located on the control board of your operator. Your LEARN button may have a different name (RADIO button, XMITTER button, etc.). For help locating your LEARN button or DIP switches contact your gate operator manufacturer.

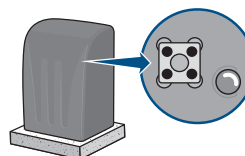

EXTERNAL RECEIVER

Some products do not have a LEARN button or DIP switches. In this case, the LEARN button or DIP switches will be located in an external receiver. The receiver will be located on the product or mounted nearby. Follow the programming instructions for an external receiver.

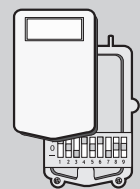

GARAGE DOOR OPENERS

Programming to a Garage Door Opener with a LEARN Button

The LEARN button is typically located on the back or side panel of the garage door opener or an external receiver. For help locating your LEARN button refer to the Help section in this manual or contact your garage door opener manufacturer.

If you have a Genie® IntelliCode® 2 garage door opener go to the next page.

The images throughout this manual are for reference only and your product may look different.

- 1 Press the program button on the remote control until the LED turns on.

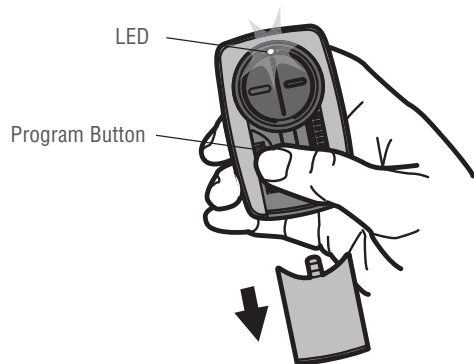

- 2 Press and release the LEARN button* on your garage door opener.

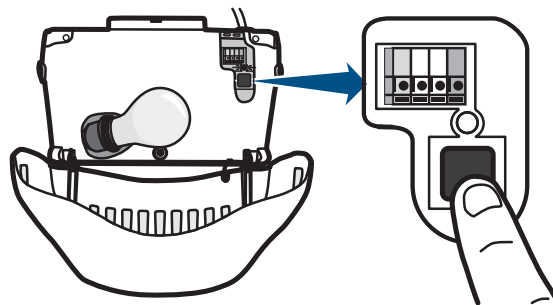

* Depending on your product, the LEARN button may have a different name (use the button for programming remote controls).

- 3 Press and release the remote control button, the LED will flash. When the LED stops flashing, continue to press and release the button (maximum of 9 times) until your garage door opener responds by clicking, blinking, or activating.

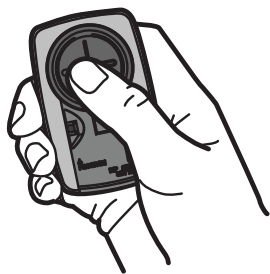

- 4 Press the program button on the remote control to save.

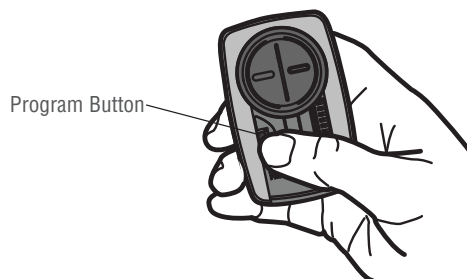

- 5 Test the remote control by pressing the button. If the garage door opener does not activate, repeat the programming steps or follow the alternative programming option.

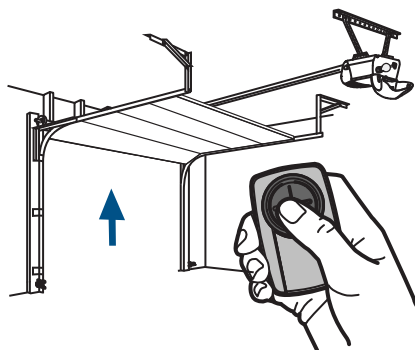

GARAGE DOOR OPENERS (continued)

Programming to a Genie® Intellicode® 2 Garage Door Opener

Before starting, you **MUST** have a Genie® Intellicode® 2 remote control with at least one button already programmed to the garage door opener.

The images throughout this manual are for reference only and your product may look different.

- 1** Press the program button on the Universal Remote Control until the LED turns on.

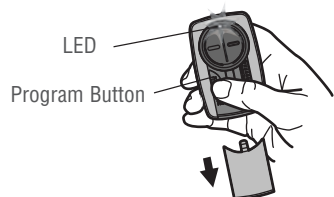

- 2** Select a button to program and press that button 5 times, ensuring the LED stops flashing after each press.

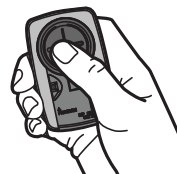

- 3** Press the program button on the Universal Remote Control.

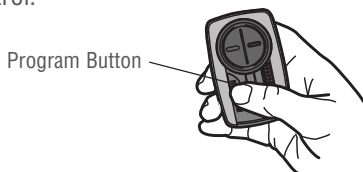

- 4** On the garage door opener, press and hold the Program/Set button until both the long and short LED light up BLUE.

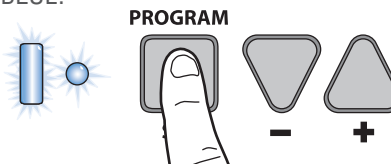

- 5** Release the Program/Set button and only the round LED will be lit in BLUE.

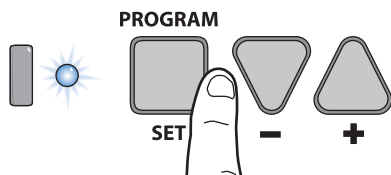

- 6** Press and release the Program/Set button and the long LED will flash PURPLE.

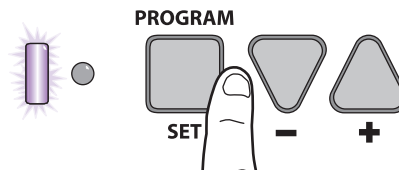

- 7** On the Genie® remote control, press and release the button that is already programmed to the garage door opener. Both LED's will flash PURPLE.

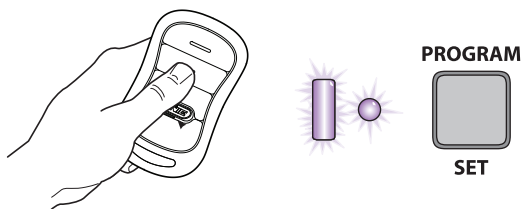

- 8** On the Universal Remote Control, press and release the same button you have already selected in step 2. Both LEDs on the garage door opener will light up PURPLE.

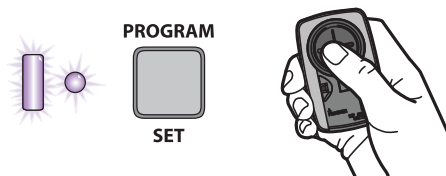

- 9** On the Universal Remote Control, press and release the same button again. Both LED's on the garage door opener will light up BLUE.

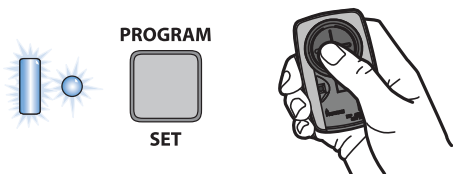

- 10** On the Universal Remote Control, press and release the same button again. This will activate the garage door opener and programming is complete. If the door does not activate, repeat the steps.

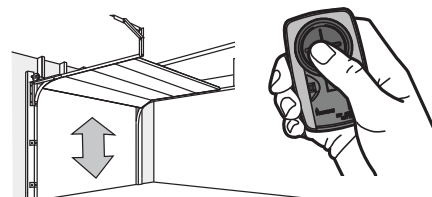

COMMERCIAL DOOR OPERATORS

Programming to a Commercial Door Operator with a LEARN Button

The LEARN button is typically located on the logic board of the operator or an external receiver. For help locating your LEARN button contact your commercial door operator manufacturer.

The images throughout this manual are for reference only and your product may look different.

- 1 Press the program button on the remote control until the LED turns on.

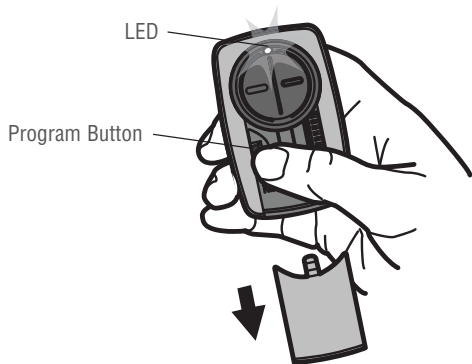

- 2 Press and release the LEARN button* on your commercial door operator.

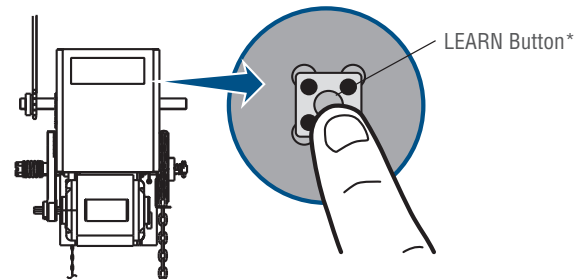

* Depending on your product, the LEARN button may have a different name (use the button for programming remote controls).

- 3 Press and release the remote control button, the LED will flash. When the LED stops flashing, continue to press and release the button until your commercial door operator responds by clicking, blinking, or activating.

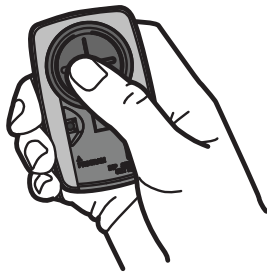

- 4 Press the program button on the remote control to save.

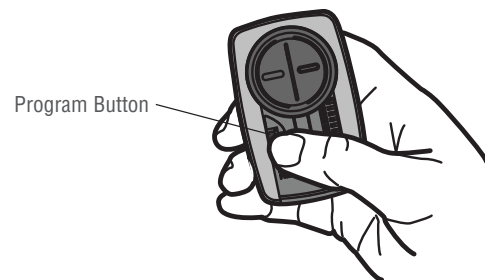

- 5 Test the remote control by pressing the button. If the commercial door operator does not activate, repeat the programming steps or follow the alternative programming option.

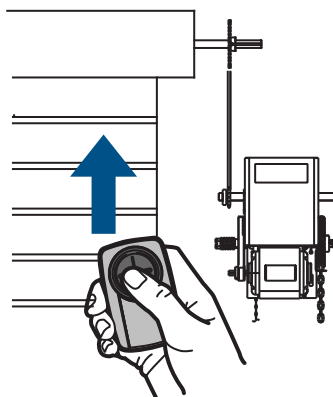

GATE OPERATORS

Programming to a Gate Operator with a LEARN Button

The LEARN button is typically located on the control board of the operator or an external receiver. For help locating your LEARN button contact your gate operator manufacturer.

The images throughout this manual are for reference only and your product may look different.

- 1 Press the program button on the remote control until the LED turns on.

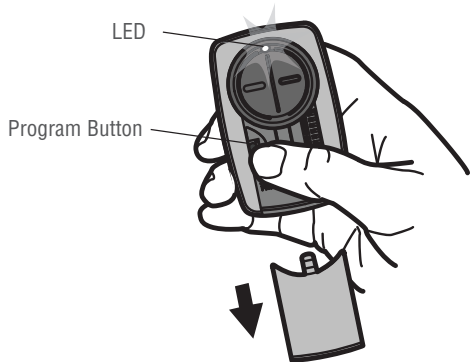

- 2 Press and release the LEARN button* on your gate operator.

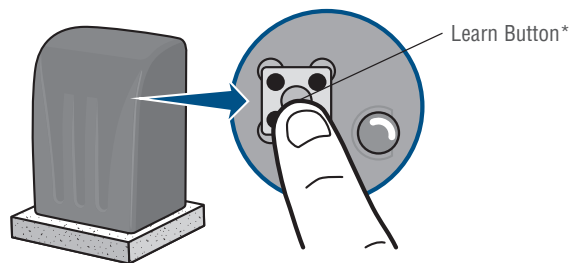

* Depending on your product, the LEARN button may have a different name (use the button for programming remote controls).

- 3 Press and release the remote control button, the LED will flash. When the LED stops flashing, continue to press and release the button until your gate operator responds by clicking, blinking, or activating.

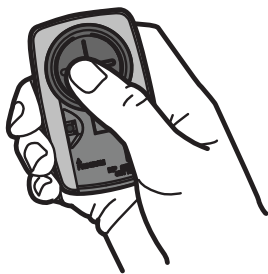

- 4 Press the program button on the remote control to save.

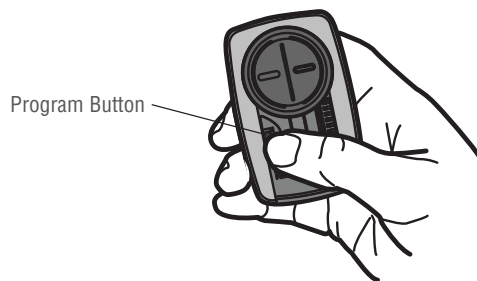

- 5 Test the remote control by pressing the button. If the gate operator does not activate, repeat the programming steps or follow the alternative programming option.



GATE OPERATORS (continued)

Programming to a GTO/Mighty Mule Gate Operator without a Remote Control

If you have an existing GTO remote control go to the next page.

The images throughout this manual are for reference only and your product may look different.

- 1** Set the remote control DIP switches 1-9 to any combination.

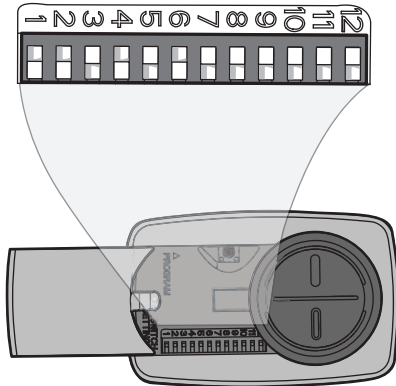

- 2** Press the program button on the remote control until the LED turns on.

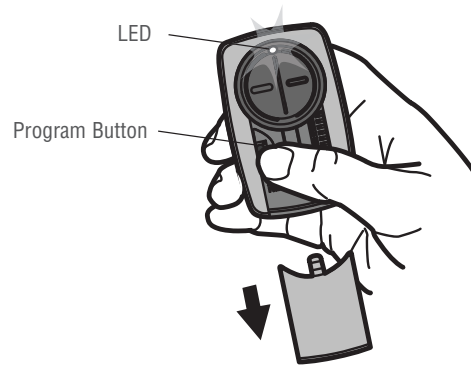

- 3** Press and release the remote control button, the LED will flash. When the LED stops flashing, continue to press and release the button 20 times, *ensuring the LED stops flashing after each press*. The code is accepted when the gate operator is activated.



- 4** Press the program button on the remote control to save.

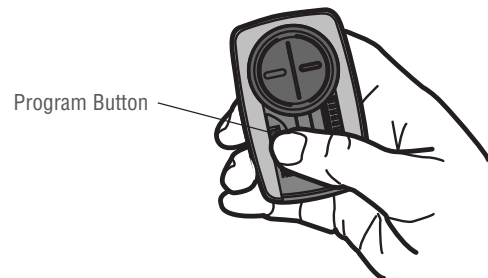

- 5** Program the remote control to the gate operator (refer to the gate operator instructions).



- 6** Test the remote control by pressing the button. If the gate operator does not activate, repeat the programming steps.



GATE OPERATORS (continued)

Programming to a GTO/Mighty Mule Gate Operator with a Remote Control



If you don't have an existing GTO remote control go to the previous page.

Before beginning, check the DIP switches on the GTO remote control. If any of the DIP switches are in the "0" position, move them to either the "+" or "-" position and reprogram the GTO remote control to the gate operator (refer to the gate operator instructions).

The images throughout this manual are for reference only and your product may look different.

INITIAL SETUP

2-BUTTON GTO REMOTE CONTROL

If the right button on the GTO remote control is programmed to the gate operator, the GTO remote control will need to be reprogrammed using the left button.

3-BUTTON GTO REMOTE CONTROL

If the middle button on the GTO remote control is programmed to the gate operator, the GTO remote control will need to be reprogrammed using either the left or right button.

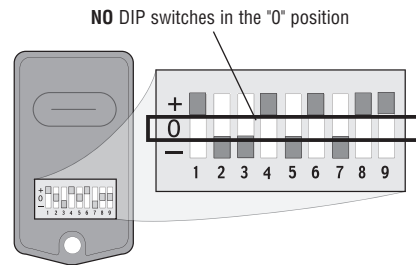

- 1** Match the Universal Remote Control DIP switches to the GTO remote control DIP switches:
GTO "+" = Universal Remote Control "ON"
GTO "-" = Universal Remote Control "OFF"

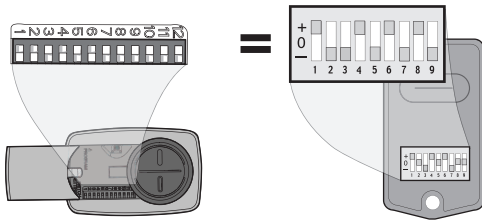

- 2** **2-BUTTON GTO REMOTE CONTROLS ONLY:** Set the 9th DIP switch on the Universal Remote Control to the "ON" position.
3-BUTTON GTO REMOTE CONTROLS ONLY: Set the 9th DIP switch on the Universal Remote Control to the "ON" position if using the GTO left button or the "OFF" position if using the GTO right button.

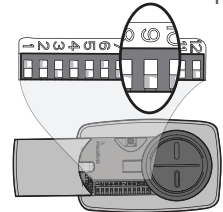

- 3** Press the program button on the Universal Remote Control until the LED turns on.

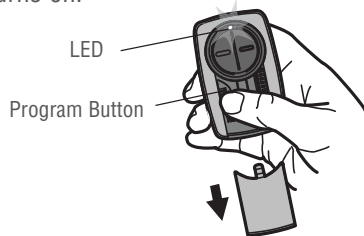

- 4** Press and release the Universal Remote Control button, the LED will flash. When the LED stops flashing, continue to press and release the button 20 times, *ensuring the LED stops flashing after each press*. The code is accepted when the gate operator is activated.



- 5** Press the program button on the Universal Remote Control to save.

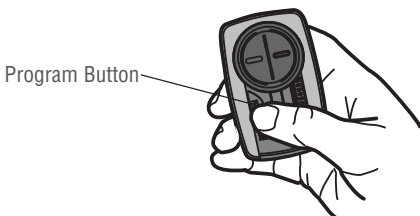

- 6** Test the Universal Remote Control by pressing the button. If the gate operator does not activate, repeat the programming steps.



EXTERNAL RECEIVERS

Programming to an External Receiver with DIP Switches



If using the Universal Remote Control with residential door openers, the remote control must be used only with door openers manufactured after 1993 that utilize photoelectric sensors. The photoelectric sensors are always located on or near the bottom of the door track.

The external receiver is typically located on the product or mounted near the product.

The images throughout this manual are for reference only and your product may look different.

- 1** Match the DIP switches between the existing remote control or external receiver and the Universal Remote Control. Turn extra switches OFF.

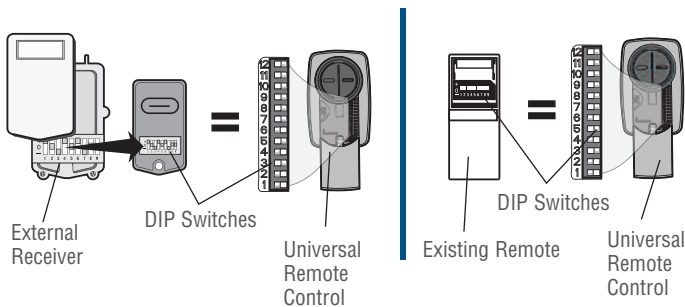

- 2** Press the program button on the Universal Remote Control until the LED turns on.

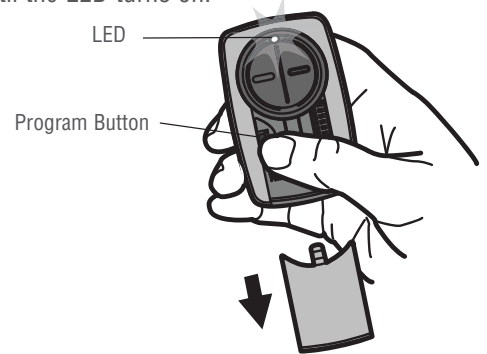

- 3** Press and release the Universal Remote Control button, the LED will flash. When the LED stops flashing, continue to press and release the button until your product responds by clicking, blinking, or activating.

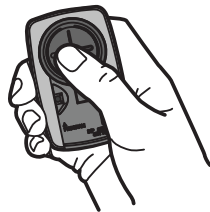

- 4** Press the program button on the Universal Remote Control to save.

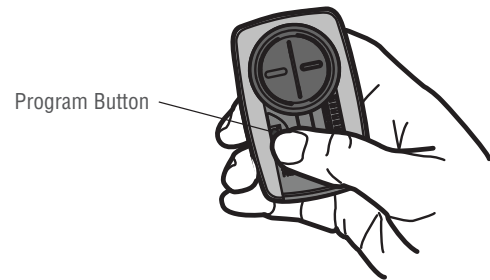

- 5** Test the Universal Remote Control by pressing the button. If the product does not activate, repeat the programming steps or follow the alternative programming option.

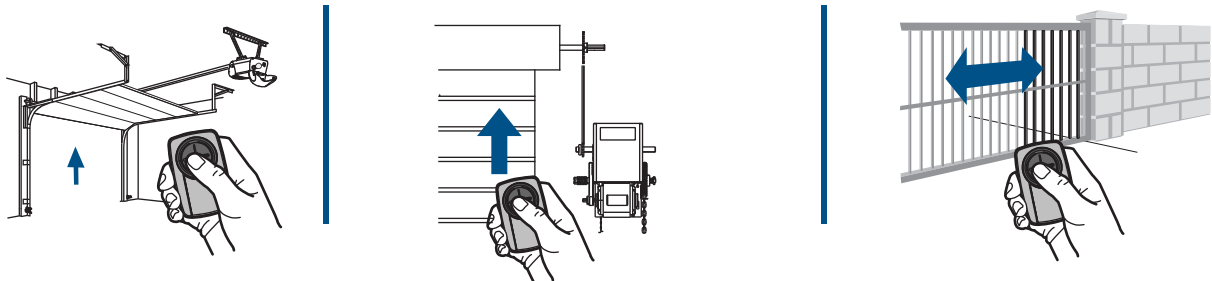

TIPS

2 Position DIP Switch:

If programming fails reverse DIP switches (OFF to ON and ON to OFF).



3 Position DIP Switch:

For Chamberlain remotes DO NOT use the "0" position, use "+" or "-". If you already have a 3-button remote, DIP switch #1 must be set to "-" if the large button is to open the door. It may be necessary to reprogram original remote controls.

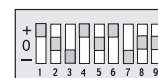

EXTERNAL RECEIVERS (continued)

Programming to an External Receiver with a LEARN Button



If using the Universal Remote Control with residential door openers, the remote control must be used only with door openers manufactured after 1993 that utilize photoelectric sensors. The photoelectric sensors are always located on or near the bottom of the door track.

The external receiver is typically located on the product or mounted near the product.

The images throughout this manual are for reference only and your product may look different.

- 1 Press the program button on the remote control until the LED turns on.

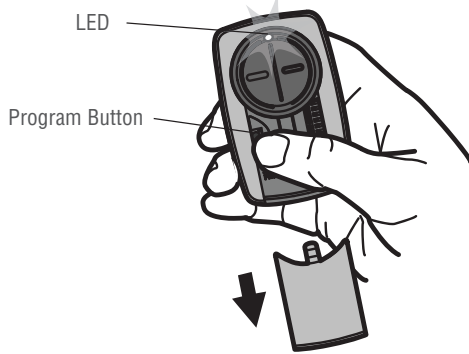

- 2 Press and release the LEARN button* on the external receiver.

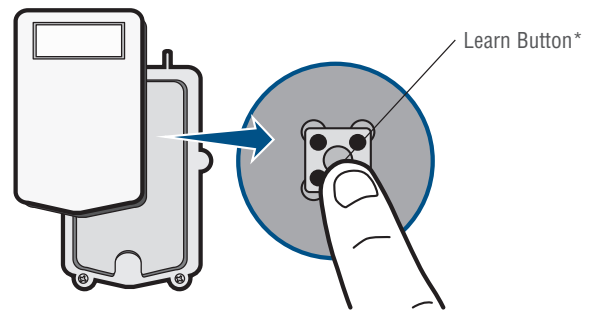

* Depending on your product, the SMART/LEARN button may have a different name (use the button for programming remote controls).

- 3 Press and release the remote control button, the LED will flash. When the LED stops flashing, continue to press and release the button until your product responds by clicking, blinking, or activating.

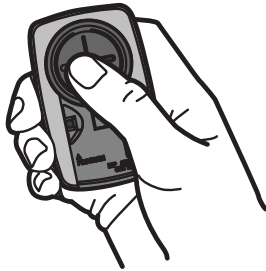

- 4 Press the program button on the remote control to save.

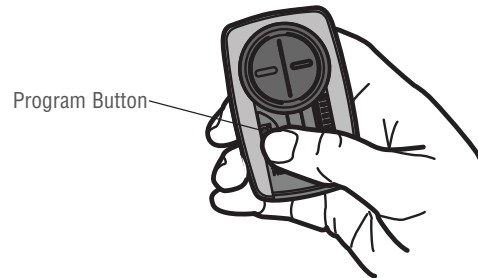

- 5 Test the remote control by pressing the button. If the product does not activate, repeat the programming steps or follow the alternative programming option.

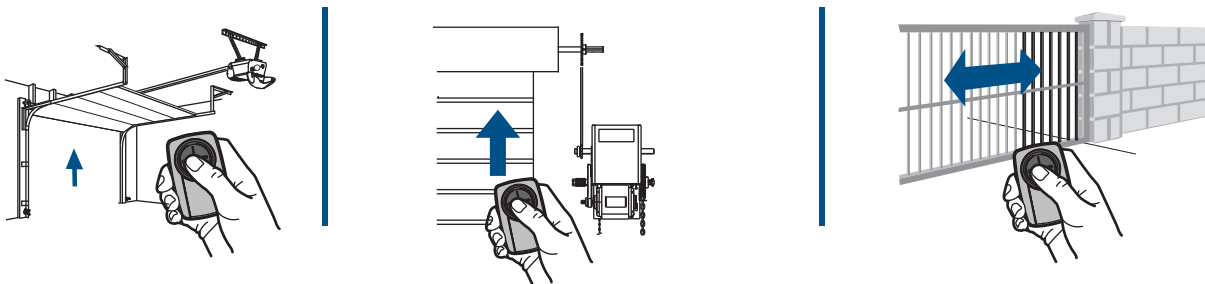

ALTERNATIVE PROGRAMMING OPTIONS

Alternative programming option for products with a LEARN Button

The LEARN button is typically located on the product or an external receiver. For help locating your LEARN button refer to the Help section in this manual or contact your product manufacturer.

The images throughout this manual are for reference only and your product may look different.

** LiftMaster, Do-It, Master Mechanic, Raynor, True Value and Sears Craftsman are compatible with Chamberlain technology.

- 1** Press the program button on the remote control until the LED turns on.

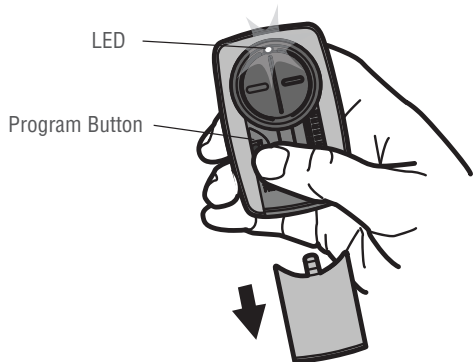

- 2** Press and release the LEARN button* on your product.

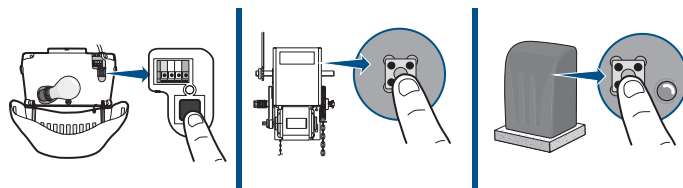

* Depending on your product, the LEARN button may have a different name (use the button for programming remote controls).

- 3** Press and release the remote control button...

- ...8 times (Chamberlain[®]** product with **yellow** LEARN button).
- ...3 times (Chamberlain[®]** product with **purple** LEARN button).
- ...2 times (Chamberlain[®]** product with **orange** LEARN button).
- ...4 times (Chamberlain[®]** product with **green** LEARN button).
- ...5 or 6 times (Overhead Door[®] Genie[®] Intellicode product).
- ...1 time (Linear[®] Mega-Code product).
- ...7 times (Stanley[®] Secure Code product).
- ...9 times (Wayne Dalton[®] Rolling Code product).

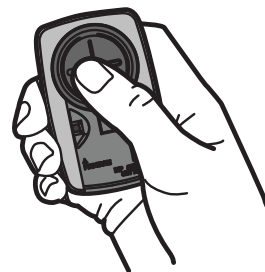

The LED on the remote control must stop blinking between each press of the button. The code is accepted when the product responds by clicking, blinking, or activating.

- 4** Press the program button on the remote control to save.

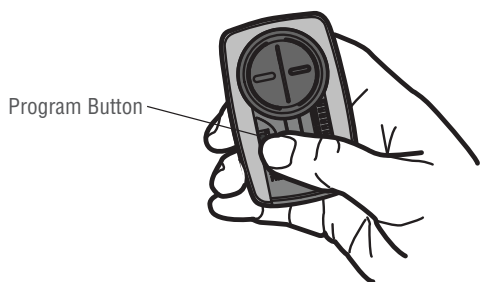

- 5** Test the remote control by pressing the button. If the product does not activate, repeat the programming steps.

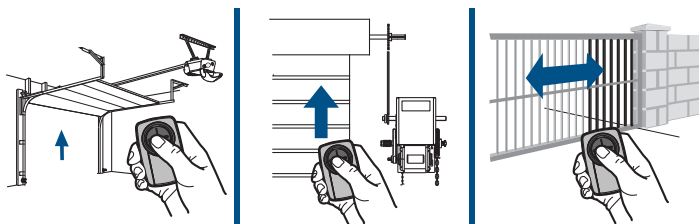

ALTERNATIVE PROGRAMMING OPTIONS (continued)

Alternative programming option for products with DIP Switches



If using the Universal Remote Control with residential door openers, the remote control must be used only with door openers manufactured after 1993 that utilize photoelectric sensors. The photoelectric sensors are always located on or near the bottom of the door track.

The DIP switches are typically located on the product or an external receiver. For help locating your DIP switches contact your product manufacturer.

The images throughout this manual are for reference only and your product may look different.

** LiftMaster, Do-It, Master Mechanic, Raynor, True Value and Sears Craftsman are compatible with Chamberlain technology.

- 1** Match the DIP switches between the existing remote control or external receiver and the Universal Remote Control. Turn extra switches OFF.

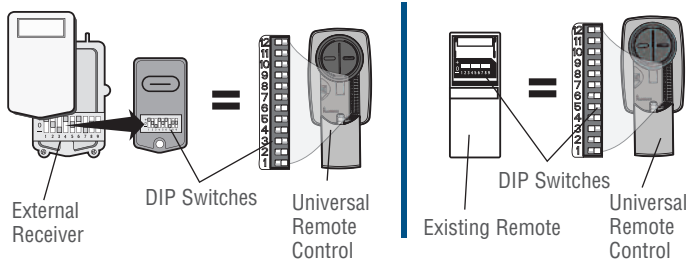

- 2** Press the program button on the Universal Remote Control until the LED turns on.

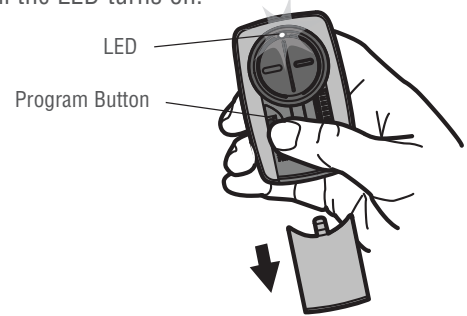

- 3** Press and release the Universal Remote Control button...

- ...11 times (Chamberlain®** product with 9 DIP switches).
- ...12 times (Chamberlain®** Canada product with 9 DIP switches).
- ...13 times (Genie® product with 12 DIP switches).
- ...14 times (Linear Multicode® with 10 DIP switches).
- ...15 times (Chamberlain®* product with 8 DIP switches).
- ...16 times (Stanley/Multicode® product with 10 DIP switches).
- ...17 times (Genie® product with 9 DIP switches).
- ...18 times (Linear®, Moore-O-Matic® product with 8 DIP switches).
- ...19 times (Chamberlain®** product with 7 DIP switches).

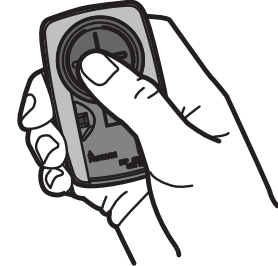

The LED on the Universal Remote Control must stop blinking between each press of the button. The code is accepted when the garage door opener responds by clicking, blinking, or activating.

- 5** Press the program button on the Universal Remote Control to save.

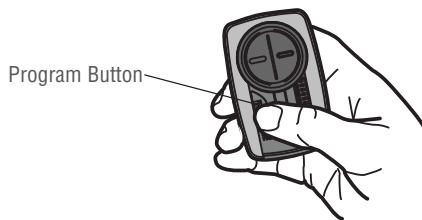

- 6** Test the Universal Remote Control by pressing the button. If the product does not activate, repeat the programming steps.

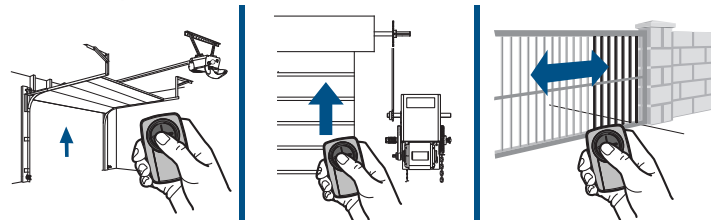

TIPS

2 Position DIP Switch:

If programming fails reverse DIP switches (OFF to ON and ON to OFF).



3 Position DIP Switch:

For Chamberlain remote controls DO NOT use the "0" position, use "+" or "-". If you already have a 3-button remote, DIP switch #1 must be set to "-" if the large button is to open the door. It may be necessary to reprogram original remote controls.



NEED HELP?

The remote control will not program to a product with DIP switches.

- Check the battery in the remote control. The LED should light when you press a button. Replace the battery if necessary.
- If programming with 2 position DIP switches, reverse the DIP switches (OFF to ON and ON to OFF), then repeat the programming steps.
- For Chamberlain remote controls DO NOT use the "0" position, use "+" or "-". If you already have a 3-button remote, DIP switch #1 must be set to "-" if the large button is to open the door. It may be necessary to reprogram original remote controls.
- Repeat the programming steps but make sure the LED stops flashing between each press of the remote control button.
- Try programming using the Alternative Programming Option for products with a LEARN button.

The remote control will not program to a product with a LEARN button.

- Check the battery in the remote control. The LED should light when you press a button. Replace the battery if necessary.
- Repeat the programming steps but make sure the LED stops flashing between each press of the remote control button.
- Try programming using the Alternative Programming Option for products with DIP switches.

The remote control LED will not light or it is dim.

- Replace the battery.

The remote control LED does not activate the product until it is close to the product.

- Replace the battery.

NEED HELP?

Locate the LEARN button

CHAMBERLAIN PRODUCTS

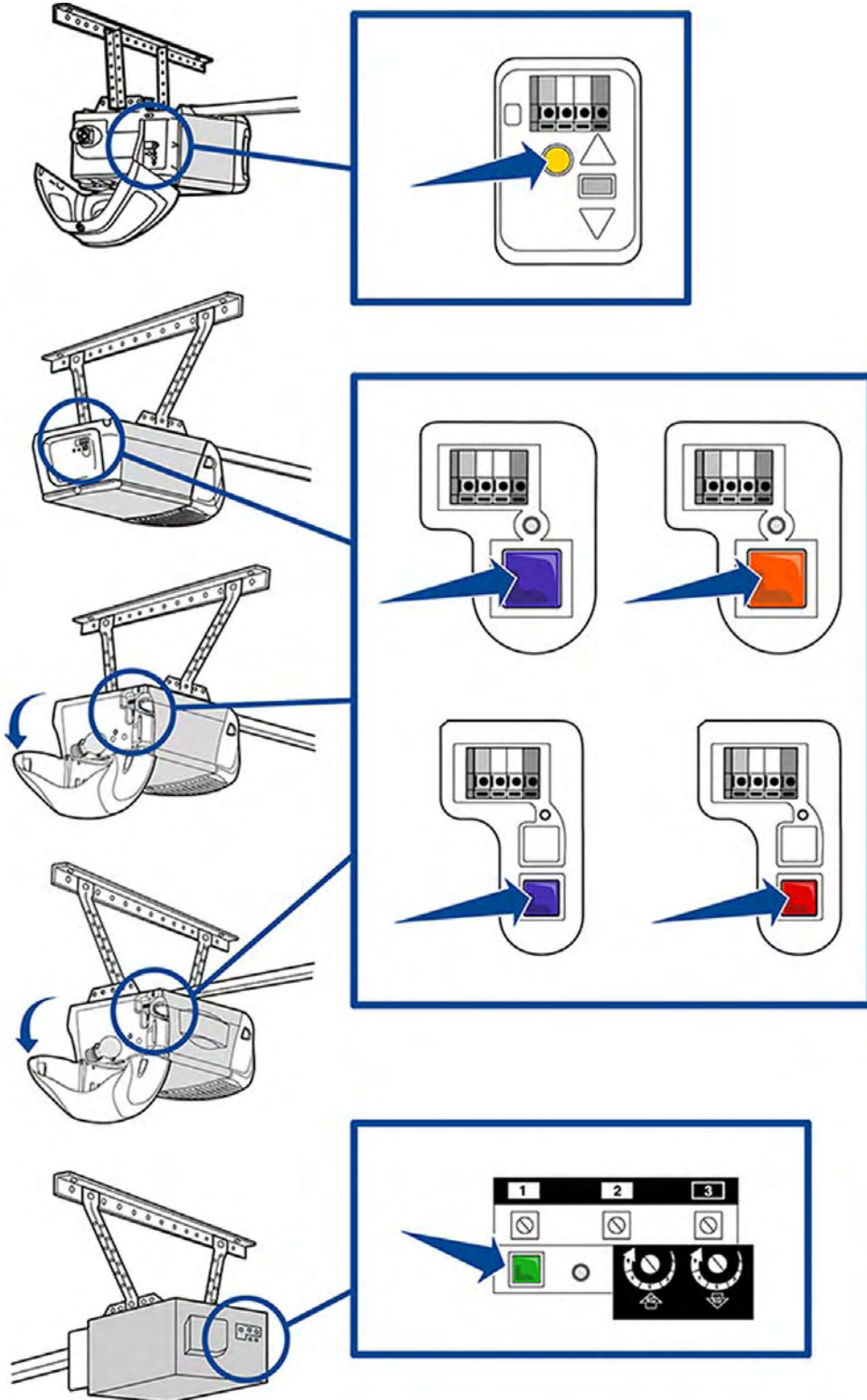

NEED HELP?

Locate the LEARN button

GENIE PRODUCTS

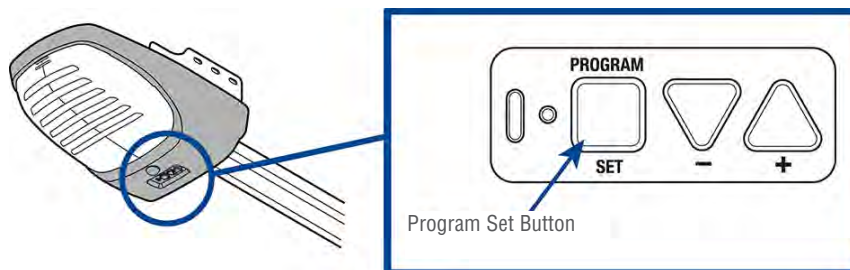
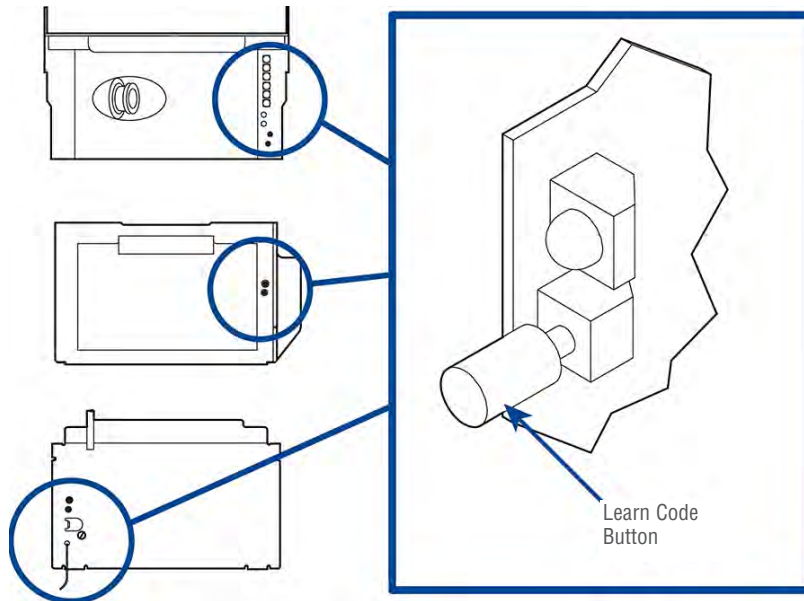

NEED HELP?

Locate the LEARN button

LINEAR PRODUCTS

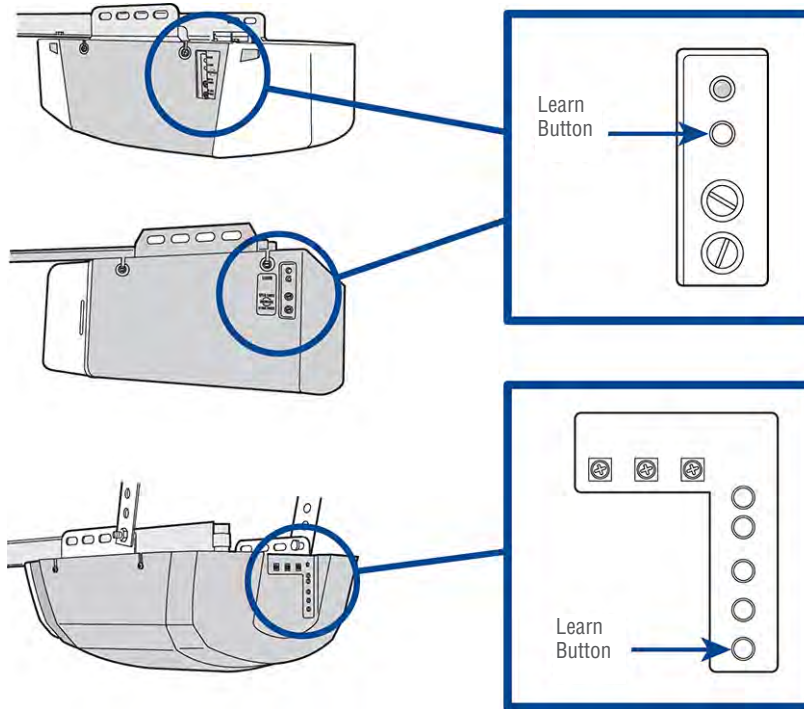

WAYNE DALTON PRODUCTS

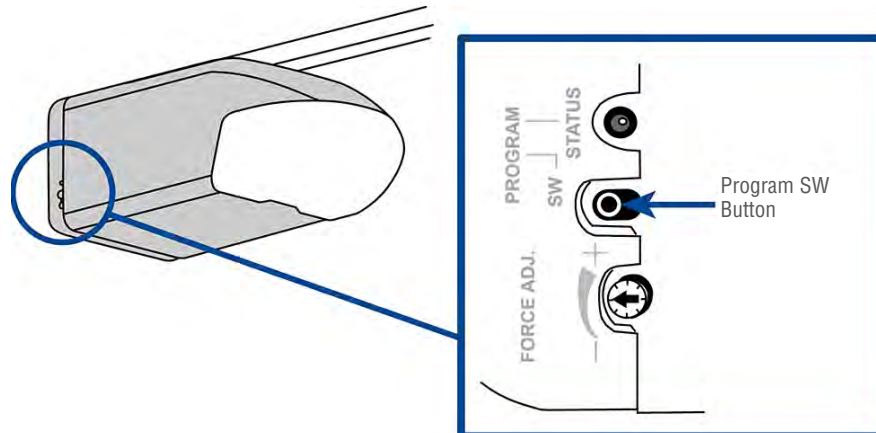

NEED HELP?

Locate the LEARN button

LIFTMASTER PRODUCTS

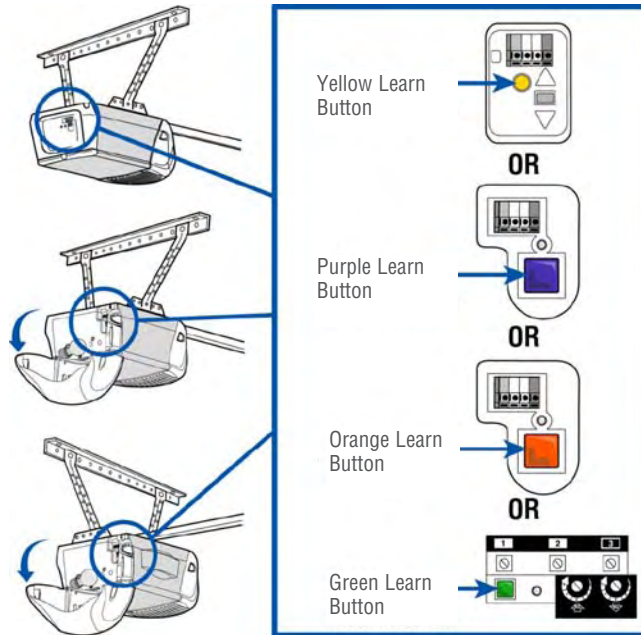

OVERHEAD DOOR PRODUCTS

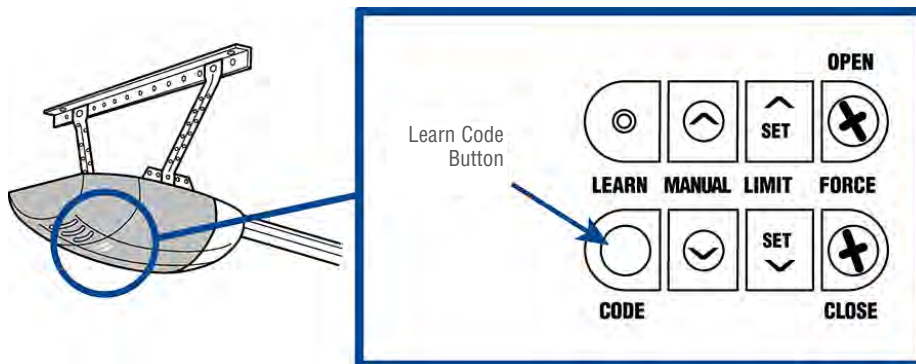

NEED HELP?

Locate the LEARN button

STANLEY PRODUCTS

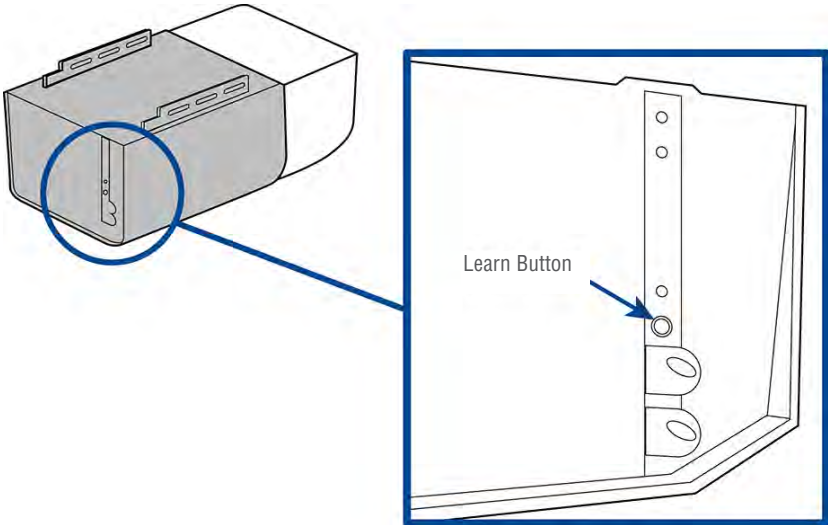

BATTERY

WARNING

To prevent possible **SERIOUS INJURY** or **DEATH**:

- NEVER allow small children near batteries.
- If battery is swallowed, immediately notify doctor.

To reduce risk of fire, explosion or chemical burn:

- Replace **ONLY** with 3V2032 coin batteries.
- **DO NOT** recharge, disassemble, heat above 212°F (100°C) or incinerate.

NOTICE: To comply with FCC and or Industry Canada (IC) rules, adjustment or modifications of this receiver and/or transmitter are prohibited, except for changing the code setting or replacing the battery. THERE ARE NO OTHER USER SERVICEABLE PARTS.

Tested to Comply with FCC Standards FOR HOME OR OFFICE USE. Operation is subject to the following two conditions: (1) this device may not cause harmful interference, and (2) this device must accept any interference received, including interference that may cause undesired operation.

Dispose of batteries properly. Replace **ONLY** with 3V2032 coin batteries.

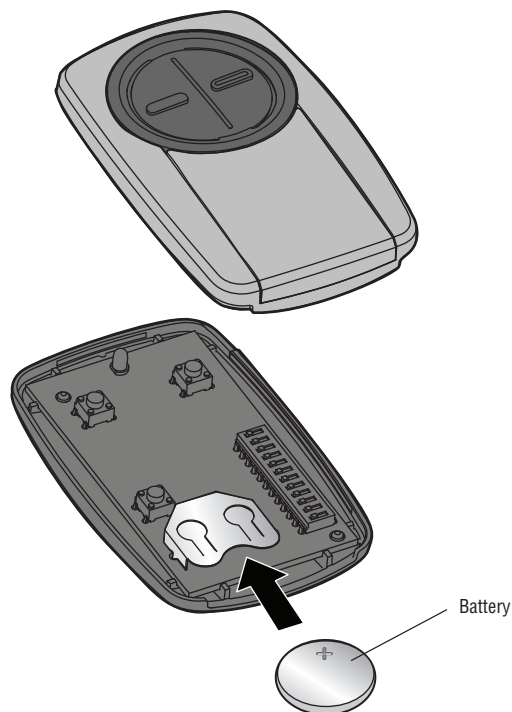

www.chamberlain.com

1-800-442-1255

Chamberlain and LiftMaster are Trademarks of Chamberlain Group. Genie is a Trademark of Overhead Door Corporation. Overhead Door is a Trademark of Overhead Door Corporation. Linear is a Trademark of Linear Corporation. Master Mechanic is a Trademark of TruServ. Sears is a Trademark of Sears & Roebuck. Stanley is a Trademark of The Stanley Works. Wayne Dalton is a trademark of Wayne Dalton Corporation. Do It is a trademark of Do It Best Corporation. Mighty Mule and GTO are trademarks of Nortek Inc.

© 2014, The Chamberlain Group, Inc.
All Rights Reserved

114A4748 Online